

PRELIMINARY

NEC NEC LCD Technologies, Ltd.

TFT COLOR LCD MODULE

NL160120AC27-20

54 cm (21.3 Type)

UXGA

LVDS Interface (2 ports)

PRELIMINARY DATA SHEET

DOD-PD-0280 (1st edition)



**All information is subject to change without notice.
Please confirm the sales representative before
starting to design your system.**

INTRODUCTION

The Copyright to this document belongs to NEC LCD Technologies, Ltd. (hereinafter called "NEC"). No part of this document will be used, reproduced or copied without prior written consent of NEC.

NEC does and will not assume any liability for infringement of patents, copyrights or other intellectual property rights of any third party arising out of or in connection with application of the products described herein except for that directly attributable to mechanisms and workmanship thereof. No license, express or implied, is granted under any patent, copyright or other intellectual property right of NEC.

Some electronic parts/components would fail or malfunction at a certain rate. In spite of every effort to enhance reliability of products by NEC, the possibility of failures and malfunction might not be avoided entirely. To prevent the risks of damage to death, human bodily injury or other property arising out thereof or in connection therewith, each customer is required to take sufficient measures in its safety designs and plans including, but not limited to, redundant system, fire-containment and anti-failure.

The products are classified into three quality grades: "**Standard**", "**Special**", and "**Specific**" of the highest grade of a quality assurance program at the choice of a customer. Each quality grade is designed for applications described below. Any customer who intends to use a product for application other than that of Standard quality grade is required to contact an NEC sales representative in advance.

The **Standard** quality grade applies to the products developed, designed and manufactured in accordance with the NEC standard quality assurance program, which are designed for such application as any failure or malfunction of the products (sets) or parts/components incorporated therein a customer uses are, directly or indirectly, free of any damage to death, human bodily injury or other property, like general electronic devices.

Examples: Computers, office automation equipment, communications equipment, test and measurement equipment, audio and visual equipment, home electronic appliances, machine tools, personal electronic equipment, industrial robots, etc.

The **Special** quality grade applies to the products developed, designed and manufactured in accordance with an NEC quality assurance program stricter than the standard one, which are designed for such application as any failure or malfunction of the products (sets) or parts/components incorporated therein a customer uses might directly cause any damage to death, human bodily injury or other property, or such application under more severe condition than that defined in the Standard quality grade without such direct damage.

Examples: Control systems for transportation equipment (automobiles, trains, ships, etc.), traffic control systems, anti-disaster systems, anti-crime systems, medical equipment not specifically designed for life support, safety equipment, etc.

The **Specific** quality grade applies to the products developed, designed and manufactured in accordance with the standards or quality assurance program designated by a customer who requires an extremely higher level of reliability and quality for such products.

Examples: Military systems, aircraft control equipment, aerospace equipment, nuclear reactor control systems, medical equipment/devices/systems for life support, etc.

The quality grade of this product is the "**Standard**" unless otherwise specified in this document.

PRELIMINARY

CONTENTS

INTRODUCTION	2
1. OUTLINE.....	5
1.1 STRUCTURE AND PRINCIPLE.....	5
1.2 APPLICATION.....	5
1.3 FEATURES.....	5
2. GENERAL SPECIFICATIONS	6
3. BLOCK DIAGRAM.....	7
4. DETAILED SPECIFICATIONS	8
4.1 MECHANICAL SPECIFICATIONS.....	8
4.2 ABSOLUTE MAXIMUM RATINGS	8
4.3 ELECTRICAL CHARACTERISTICS.....	9
4.3.1 LCD panel signal processing board	9
4.3.2 Inverter.....	10
4.3.3 Inverter current wave.....	10
4.3.4 Power supply voltage ripple.....	11
4.3.5 Fuse.....	11
4.4 POWER SUPPLY VOLTAGE SEQUENCE	12
4.4.1 LCD panel signal processing board	12
4.4.2 Inverter.....	12
4.5 CONNECTIONS AND FUNCTIONS FOR INTERFACE PINS.....	13
4.5.1 LCD panel signal processing board	13
4.5.2 Inverter.....	14
4.5.3 Positions of socket	15
4.6 LUMINANCE CONTROL.....	16
4.6.1 Luminance control methods.....	16
4.6.2 Detail of BRTP timing	17
4.7 LVDS DATA INPUT MAP.....	18
4.7.1 Mode A	18
4.7.2 Mode B	19
4.7.3 Mode C	20
4.8 DISPLAY COLORS AND INPUT DATA SIGNALS	21
4.9 INPUT SIGNAL TIMINGS.....	22
4.9.1 Timing characteristics	22
4.9.2 Input signal timing chart.....	22
4.10 DISPLAY POSITIONS.....	23
4.11 TEN-bit LOOK UP TABLE FOR GAMMA ADJUSTMENT	24
4.12 LUT SERIAL COMMUCATION TIMINGS	27
4.12.1 Timing Chart.....	27
4.12.2 Timing specifications	28
4.13 OPTICS.....	29
4.13.1 Optical characteristics.....	29
4.13.2 Definition of contrast ratio.....	30
4.13.3 Definition of luminance uniformity	30
4.13.4 Definition of response times	30
4.13.5 Definition of viewing angles.....	30

PRELIMINARY

CONTENTS

5. RELIABILITY TESTS.....	31
6. PRECAUTIONS	32
6.1 MEANING OF CAUTION SIGNS	32
6.2 CAUTIONS	32
6.3 ATTENTIONS	32
6.3.1 Handling of the product	32
6.3.2 Environment.....	33
6.3.3 Characteristics.....	33
6.3.4 Other	34
7. OUTLINE DRAWINGS	35
7.1 FRONT VIEW	35
7.2 REAR VIEW	36
REVISION HISTORY	36

1. OUTLINE

1.1 STRUCTURE AND PRINCIPLE

Color LCD module NL160120AC27-20 is composed of the amorphous silicon thin film transistor liquid crystal display (a-Si TFT LCD) panel structure with driver LSIs for driving the TFT (Thin Film Transistor) array and a backlight.

The a-Si TFT LCD panel structure is injected liquid crystal material into a narrow gap between the TFT array glass substrate and a color-filter glass substrate.

Grayscale data signals from a host system (e.g. signal generator, etc.) are modulated into best form for active matrix system by a signal processing board, and sent to the driver LSIs which drive the individual TFT arrays.

The TFT array as an electro-optical switch regulates the amount of transmitted light from the backlight assembly, when it is controlled by data signals. Color images are created by regulating the amount of transmitted light through the TFT array of red, green and blue dots.

1.2 APPLICATION

- Color monitor system

1.3 FEATURES

- Ultra-wide viewing angle (Adoption of Super-Advanced Super Fine TFT (SA-SFT))
- High luminance
- High contrast
- High resolution
- Wide color gamut
- LVDS interface
- Adjustable gamma characteristics by using built-in 10-bit LUT (look up table)
- Selectable LVDS data input map
- Small foot print
- Incorporated direct light type backlight
- Replaceable inverter

PRELIMINARY

2. GENERAL SPECIFICATIONS

Display area	432.0 (H) × 324.0 (V) mm
Diagonal size of display	54 cm (21.3 inches)
Drive system	a-Si TFT active matrix
Display color	16,777,216 colors
Pixel	1,600 (H) × 1,200 (V) pixels (1 pixel consists of 3 sub-pixels (RGB).)
Pixel arrangement	RGB (Red dot, Green dot, Blue dot) vertical stripe
Dot pitch	0.090 (H) × 0.270 (V) mm
Pixel pitch	0.270 (H) × 0.270 (V) mm
Module size	457.0 (W) × 350.0 (H) × 34.0 (D) mm (typ.)
Weight	2,900 g (typ.)
Contrast ratio	800:1 (typ.)
Viewing angle	At the contrast ratio ≥ 10:1 <ul style="list-style-type: none"> • Horizontal: Right side 85° (typ.), Left side 85° (typ.) • Vertical: Up side 85° (typ.), Down side 85° (typ.)
Designed viewing direction	Viewing angle with optimum grayscale (γ = DICOM): normal axis (perpendicular) Note1
Polarizer surface	Antiglare
Polarizer pencil-hardness	2H (min.) [by JIS K5400]
Color gamut	At LCD panel center 72%(typ.) [against NTSC color space]
Response time	Ton+Toff (10%←→90%) 25 ms (typ.)
Luminance	At the maximum luminance control 950 cd/m ² (typ.)
Signal system	2 ports LVDS interface (THC63LVD824 THine Electronics, Inc. or equivalent) [RGB 8-bit signals, Data enable signal (DE), Dot clock (CK)]
Power supply voltage	LCD panel signal processing board: 12.0V Inverter: 24.0V
Backlight	Direct light type: 16 cold cathode fluorescent lamps with an inverter (Replaceable part) • Inverter: TBD
Power consumption	At checkered flag pattern, the maximum luminance control 80 W (typ.)

Note1: When the product luminance is 400cd/m², the gamma characteristic is designed to γ =DICOM.

3. BLOCK DIAGRAM

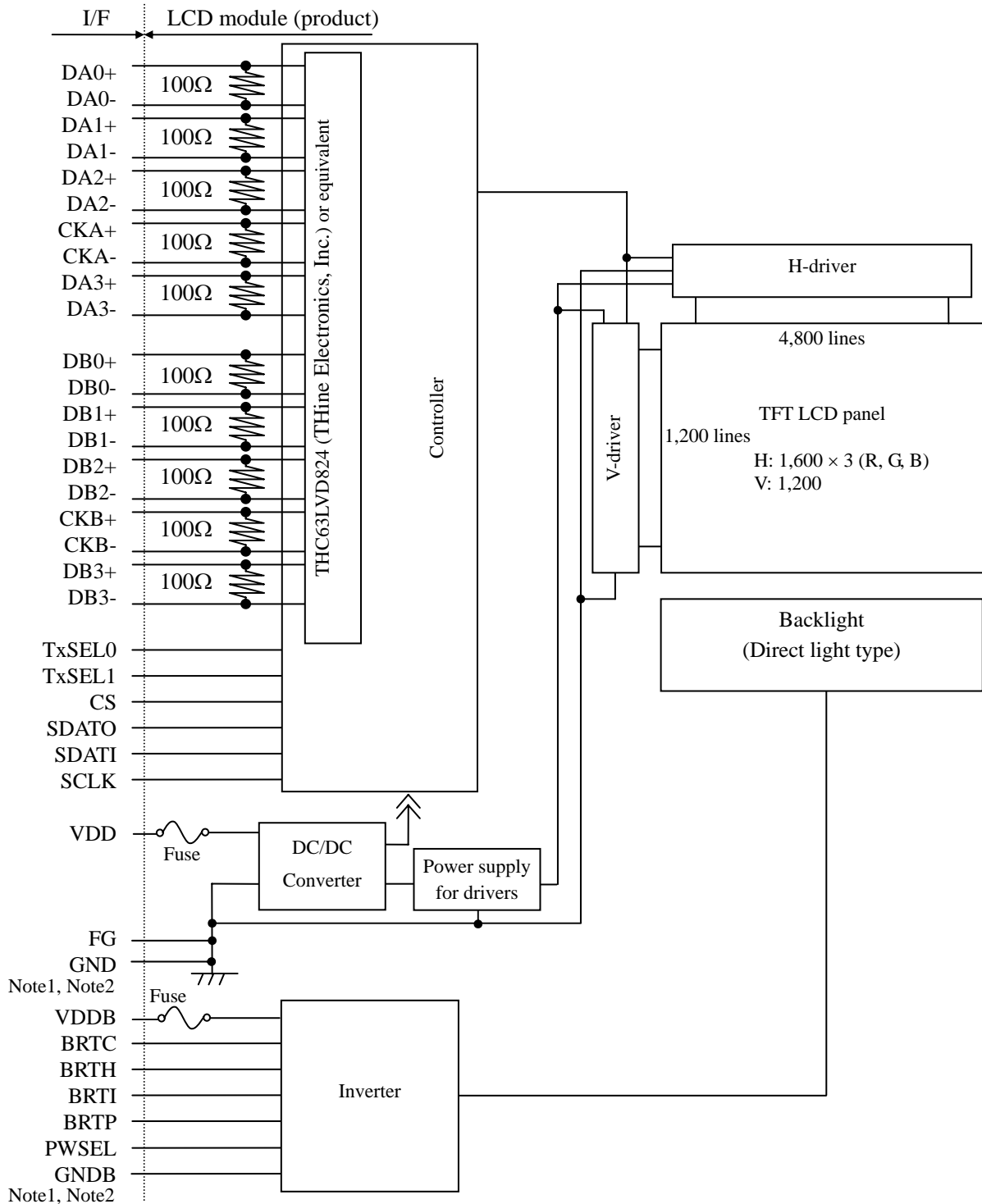

Note1: Connections between GND (Signal ground), FG (Frame ground) and GNDB (Inverter ground) in the product

GND - FG	Connected
GND - GNDB	Not connected
FG - GNDB	Not connected

Note2: GND, FG and GNDB must be connected to customer equipment's ground, and it is recommended that these grounds are connected together in customer equipment.

PRELIMINARY

4. DETAILED SPECIFICATIONS

4.1 MECHANICAL SPECIFICATIONS

Parameter	Specification	Unit
Module size	457.0 ±0.5 (W) × 350.0 ±0.5 (H) × 34.0 (typ., D) 37.0 (max. D) Note1, Note2	mm
Display area	432.0 (H) × 324.0 (V) Note1	mm
Weight	2,900(typ.), 3,100 (max.)	g

Note1: Excluding warpage of the signal processing board cover and the connection board cover

Note2: See "7. OUTLINE DRAWINGS".

4.2 ABSOLUTE MAXIMUM RATINGS

Parameter		Symbol	Rating	Unit	Remarks	
Power supply voltage	LCD panel signal processing board	VDD	-0.3 to +14.0	V	-	
	Inverter	VDDb	-0.3 to +27.0	V		
Input voltage for signals	LCD panel signal processing board Note1	V _i	-0.3 to +3.45	V	VDD= 12.0V	
	Inverter	BRTI signal	VBI	-0.3 to +1.5	V	VDDb= 12.0V
		BRTP signal	VBP	-0.3 to +5.5	V	
		BRTC signal	VBC	-0.3 to +5.5	V	
	PWSEL signal	VBS	-0.3 to +5.5	V		
Storage temperature		T _{st}	-20 to +60	°C	-	
Operating temperature	Front surface	TopF	0 to +55	°C	Note2	
	Rear surface	TopR	0 to +60	°C	Note3	
Relative humidity Note4		RH	≤ 70	%	T _a ≤ 55°C	
Absolute humidity Note4		AH	≤ 73 Note5	g/m ³	T _a > 55°C	
Operating altitude		-	≤ 4,850	m	0°C ≤ T _a ≤ 55°C	
Storage altitude		-	≤ 13,600	m	-20°C ≤ T _a ≤ 60°C	

Note1: DA0+/-, DA1+/-, DA2+/-, DA3+/-, CKA+/-, DB0+/-, DB1+/-, DB2+/-, DB3+/-, CKB+/-
CS, SDATI, SCLK, TxSEL0, TxSEL1

Note2: Measured at center of LCD panel surface (including self-heat)

Note3: Measured at center of LCD module's rear shield surface (including self-heat)

Note4: No condensation

Note5: Water amount at T_a = 55°C and RH = 70%

PRELIMINARY

4.3 ELECTRICAL CHARACTERISTICS

4.3.1 LCD panel signal processing board

(Ta = 25°C)

Parameter		Symbol	min.	typ.	max.	Unit	Remarks
Supply voltage		VDD	10.8	12.0	13.2	V	-
Supply current		IDD	-	420 Note1	700 Note2	mA	at VDD=12.0V
Ripple voltage		VRP	-	-	100	mVp-p	for VDD
Differential input threshold voltage	High	VTH	-	-	+100	mV	at VCM=1.2V Note3, Note4
	Low	VTL	-100	-	-	mV	
Input voltage swing		VI	0	-	2.4	V	Note4
Terminating resistance		RT	-	100	-	Ω	-
Control signal input threshold voltage	High	VIH	Keep this pin open.			-	Note5
	Low	VIL	0	-	0.8	V	
Control signal input current	Low	IIL	-10	-	10	μA	
Serial communication signal input threshold voltage	High	V+	-	1.98	2.07	V	Note6
	Low	V-	0.63	0.66	-	V	
	Hysteresis	VH	0.4	-	-	V	
Output signal threshold voltage	High	VOH	2.4	-	-	V	Note7
	Low	VOL	-	-	0.4	V	
Output signal current	High	IOH	-12	-	-	mA	
	Low	IOL	-	-	12	mA	

Note1: Checkered flag pattern (by EIAJ ED-2522)

Note2: Pattern for maximum current

Note3: Common mode voltage for LVDS driver

Note4: DA0+/-, DA1+/-, DA2+/-, DA3+/-, CKA+/-, DB0+/-, DB1+/-, DB2+/-, DB3+/-, CKB+/-

Note5: TxSEL0, TxSEL1

Note6: CS, SDATI, SCLK

Note7: SDATO

4.3.2 Inverter

(Ta = 25°C)

Parameter		Symbol	min.	typ.	max.	Unit	Remarks
Power supply voltage		VDDB	22.8	24.0	25.2	V	-
Power supply current		IDDB	-	3,000	TBD	mA	VDDB = 24.0V, At the maximum luminance control
Input voltage for signals	BRTI signal		VBI	0.25	-	1.0	V
	BRTP signal	High	VBPH	2.0	-	5.25	V
		Low	VBPL	0	-	0.8	V
	BRTC signal	High	VBCH	2.0	-	5.25	V
		Low	VBCL	0	-	0.8	V
	PWSEL signal	High	VBSH	2.0	-	5.25	V
Low		VBSL	0	-	0.8	V	
Input current for signals	BRTI signal		IBI	TBD	-	TBD	μA
	BRTP signal	High	IBPH	-	-	TBD	μA
		Low	IBPL	TBD	-	-	μA
	BRTC signal	High	IBCH	-	-	TBD	μA
		Low	IBCL	TBD	-	-	μA
	PWSEL signal	High	IBSH	-	-	TBD	μA
Low		IBSL	TBD	-	-	μA	

4.3.3 Inverter current wave

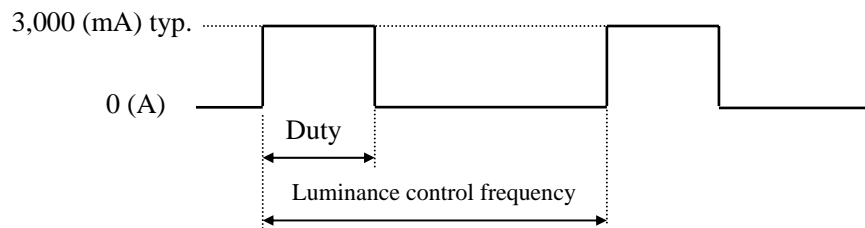

Maximum luminance control: 100%
 Minimum luminance control: 20%
 Luminance control frequency: 255Hz (typ.)

Note1: Luminance control frequency indicate the input pulse frequency, when select the external pulse control. See "4.6.2 Detail of BRTP timing".

Note2: The power supply lines (VDDB and GNDB) have large ripple voltage (See "4.3.4 Power supply voltage ripple".) during luminance control. There is the possibility that the ripple voltage produces acoustic noise and signal wave noise in audio circuit and so on. Put a capacitor (5,000 to 6,000μF) between the power supply lines (VDDB and GNDB) to reduce the noise, if the noise occurred in the circuit..

4.3.4 Power supply voltage ripple

This product works, even if the ripple voltage levels are beyond the permissible values as following the table, but there might be noise on the display image.

Power supply voltage		Ripple voltage (Measure at input terminal of power supply)	Note1	Unit
VDD	12.0 V	≤ 100		mVp-p
VDDDB	24.0 V	≤ 200		mVp-p

Note1: The permissible ripple voltage includes spike noise.

Example of the power supply connection

a) Separate the power supply

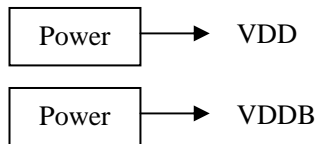

b) Put in the filter

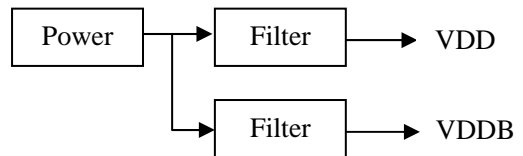

4.3.5 Fuse

Parameter	Fuse		Rating	Fusing current	Remarks
	Type	Supplier			
VDD	FCC16132AB	KAMAYA ELECTRIC Co., Ltd.	1.25A	2.5A, 5 seconds maximum	Note1
			32V		
VDDDB	TBD	TBD	TBD	TBD	
			TBD		

Note1: The power supply capacity should be more than the fusing current. If it is less than the fusing current, the fuse may not blow in a short time, and then nasty smell, smoke and so on may occur.

4.4 POWER SUPPLY VOLTAGE SEQUENCE

4.4.1 LCD panel signal processing board

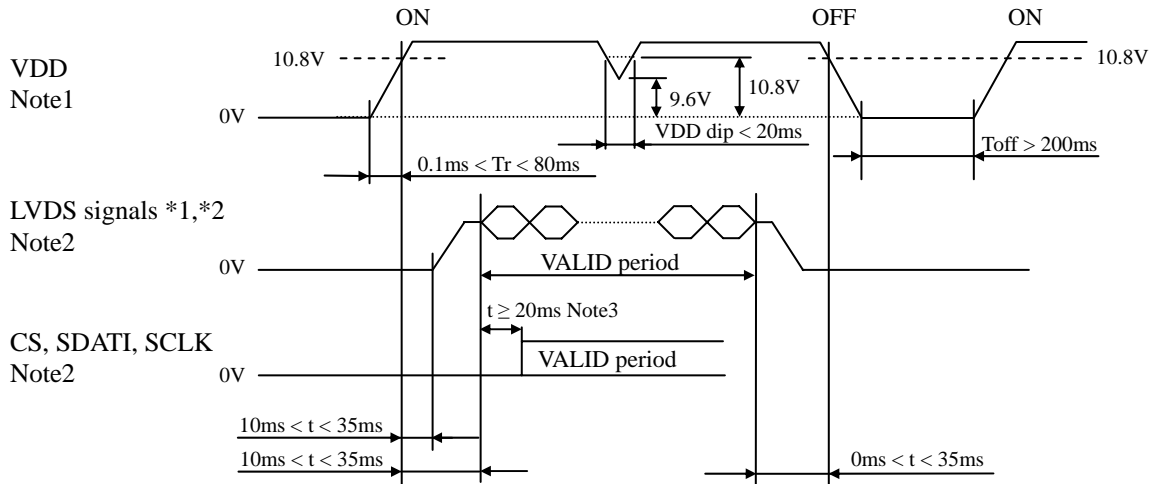

*1: DA0+/-, DA1+/-, DA2+/-, DA3+/-, CKA+/-, DB0+/-, DB1+/-, DB2+/-, DB3+/- and CKB+/-

*2: LVDS signals should be measured at the terminal of 100Ω resistance.

Note1: In terms of voltage variation (voltage drop) while VDD rising edge is below 10.8V, a protection circuit may work, and then this product may not work.

Note2: LVDS signals and CS, SDATI, SCLK must be Low or High-impedance, exclude the VALID period (See above sequence diagram), in order to avoid that internal circuits is damaged. If some of signals are cut while this product is working, even if the signal input to it once again, it might not work normally. VDD should be cut when the display and function signals are stopped.

Note3: At the beginning of the serial communication mode, take 20ms or more after the LVDS signal input. As writing and reading the LUT data, see “**4.11 TEN-bit LOOK UP TABLE FOR GAMMA ADJUSTMENT**”.

4.4.2 Inverter

TBD

PRELIMINARY

4.5 CONNECTIONS AND FUNCTIONS FOR INTERFACE PINS

4.5.1 LCD panel signal processing board

(1) CN1

Socket (LCD module side): DF19G-30P-1H (56) (Hirose Electric Co., Ltd. (HRS))

Adaptable plug: DF19-30S-1C (Hirose Electric Co., Ltd. (HRS))

Pin No.	Symbol	Signal	Remarks			
1	DA0-	Pixel data A0	Odd pixel data Input (LVDS differential signal) Note1			
2	DA0+					
3	DA1-	Pixel data A1	Odd pixel data Input (LVDS differential signal) Note1			
4	DA1+					
5	DA2-	Pixel data A2	Odd pixel data Input (LVDS differential signal) Note1			
6	DA2+					
7	GND	Ground	Signal ground Note2			
8	CKA-	Pixel clock	Odd pixel clock Input (LVDS differential signal) Note1			
9	CKA+					
10	DA3-	Pixel data A3	Odd pixel data Input (LVDS differential signal) Note1			
11	DA3+					
12	DB0-	Pixel data B0	Even pixel data Input (LVDS differential signal) Note1			
13	DB0+					
14	GND	Ground	Signal ground Note2			
15	DB1-	Pixel data B1	Even pixel data Input (LVDS differential signal) Note1			
16	DB1+					
17	GND	Ground	Signal ground Note2			
18	DB2-	Pixel data B2	Even pixel data Input (LVDS differential signal) Note1			
19	DB2+					
20	CKB-	Pixel clock	Even pixel clock Input (LVDS differential signal) Note1			
21	CKB+					
22	DB3-	Pixel data B3	Even pixel data Input (LVDS differential signal) Note1			
23	DB3+					
24	GND	Ground	Signal ground Note2			
25	TxSEL0	Selection of LVDS data input map	Note3, Note4	TxSEL1	TxSEL0	Mode
26	TxSEL1			Open	Open	A
				Open	Low	B
				Low	Open	C
		Low	Low	A		
27	GND	Ground	Signal ground Note2			
28	VDD	Power supply	12V Note2			
29	VDD					
30	VDD					

Note1: Twist pair wires with 100Ω (Characteristic impedance) should be used between LCD panel signal processing board and LVDS transmitter.

Note2: All GND and VDD terminals should be used without any non-connected lines.

Note3: This terminal is pulled-up in the product. (Pull-up resistance: 50kΩ)

Note4: See "**4.7 LVDS DATA INPUT MAP**".

PRELIMINARY

(2) CN3

Socket (LCD module side): SM10B-SRSS-TB(LF)(SN) (J.S.T. Mfg Co., Ltd.)

Adaptable plug: SHR-10V-S, SHR-10V-S-B or 10SR-3S (J.S.T. Mfg Co., Ltd.)

Pin No.	Symbol	Signal	Remarks
1	RSVD	Reserved	Keep this pin Open.
2	RSVD	Reserved	Keep this pin Open.
3	RSVD	Reserved	Keep this pin Open.
4	GND	Ground	Signal ground Note1
5	CS	Chip selection	For LUT communication control Note2
6	SDATO	Serial data output	For LUT output signal
7	SDATI	Serial data input	For LUT communication control Note3
8	SCLK	Serial clock	For LUT communication control Note3
9	GND	Ground	Signal ground Note1
10	RSVD	Reserved	Keep this pin Open.

Note1: All GND terminals should be used without any non-connected lines.

Note2: This terminal is pulled-up in the product. (Pull-up resistance: 50kΩ)

Note3: These terminals are pulled-down in the product. (Pull-down resistance: 50kΩ)

4.5.2 Inverter

CN201 socket (LCD module side): DF3Z-10P-2H (2*) (HIROSE ELECTRIC Co.,Ltd.)

Adaptable plug: DF3-10S-2C (HIROSE ELECTRIC Co.,Ltd.)

Pin No.	Symbol	Function	Description
1	GNDB	Inverter ground	Note1
2	GNDB		
3	GNDB		
4	GNDB		
5	GNDB		
6	VDDB	Power supply	Note1
7	VDDB		
8	VDDB		
9	VDDB		
10	VDDB		

Note1: All VDDB and GNDB terminals should be used without any non-connected lines.

CN202 socket (LCD module side): IL-Z-9PL-SMTYE (Japan Aviation Electronics Industry Limited (JAE))

Adaptable plug: IL-Z-9S-S125C3 (Japan Aviation Electronics Industry Limited (JAE))

Pin No.	Symbol	Function	Description
1	GNDB	Inverter ground	Note1
2	GNDB		
3	N.C.	-	Keep this pin Open.
4	BRTC	Backlight ON/OFF control signal	High or Open: Backlight ON Low: Backlight OFF
5	BRTH	Luminance control terminal	See "4.6 LUMINANCE CONTROL".
6	BRTI		
7	BRTP		
8	GNDB	Inverter ground	Note1
9	PWSEL	Selection of luminance control signal method	See "4.6 LUMINANCE CONTROL". Note2

Note1: All GNDB terminals should be used without any non-connected lines.

Note2: When VDDB is 0V or BRTC is Low, PWSEL must be set to Low or Open.

4.5.3 Positions of socket

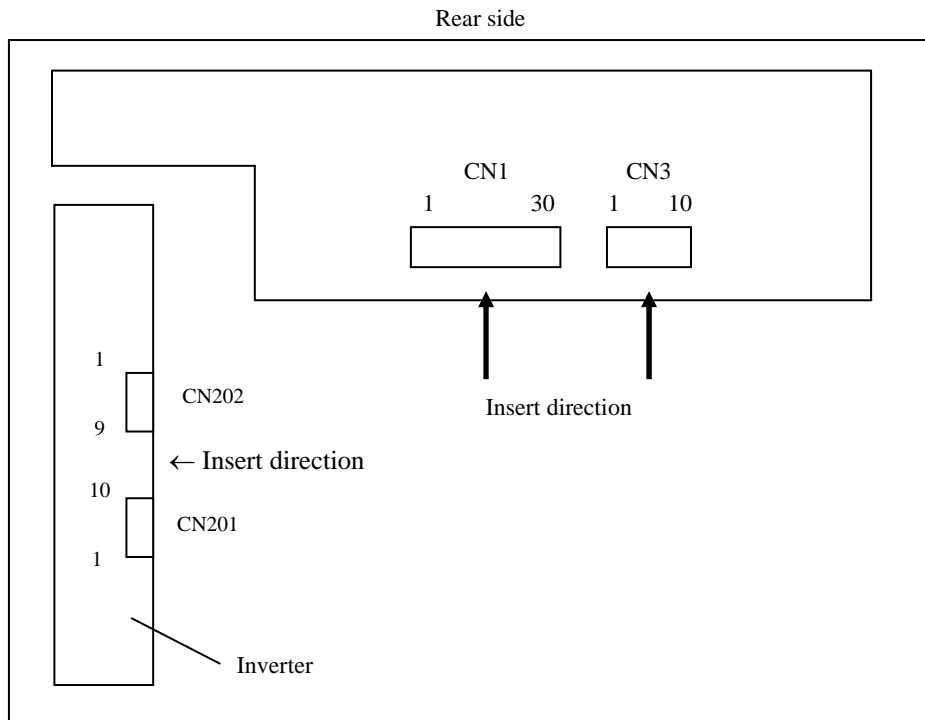

4.6 LUMINANCE CONTROL

4.6.1 Luminance control methods

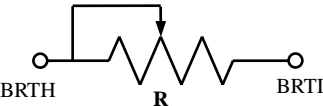
Method	Adjustment and luminance ratio	PWSEL terminal	BRTP terminal						
Variable resistor control Note1	<ul style="list-style-type: none"> • Adjustment <p>The variable resistor (R) for luminance control should be 10kΩ ±5%, 1/10W. Minimum point of the resistance is the minimum luminance and maximum point of the resistance is the maximum luminance.</p> <p>The resistor (R) must be connected between BRTH-BRTI terminals.</p> <div style="text-align: center;">  </div> <ul style="list-style-type: none"> • Luminance ratio Note3 <table border="1" style="margin-left: auto; margin-right: auto;"> <thead> <tr> <th>Resistance</th> <th>Luminance ratio</th> </tr> </thead> <tbody> <tr> <td>1.5 kΩ Note4</td> <td>20% (Min. Luminance)</td> </tr> <tr> <td>10 kΩ</td> <td>100% (Max. Luminance)</td> </tr> </tbody> </table>	Resistance	Luminance ratio	1.5 kΩ Note4	20% (Min. Luminance)	10 kΩ	100% (Max. Luminance)	High or Open	Open
Resistance	Luminance ratio								
1.5 kΩ Note4	20% (Min. Luminance)								
10 kΩ	100% (Max. Luminance)								
Voltage control Note1	<ul style="list-style-type: none"> • Adjustment <p>Voltage control method works, when BRTH terminal is 0V and VBI voltage is input between BRTI-BRTH terminals. This control method can carry out continuation adjustment of luminance.</p> <p>Luminance is the maximum when BRTI terminal is Open.</p> <ul style="list-style-type: none"> • Luminance ratio Note3 <table border="1" style="margin-left: auto; margin-right: auto;"> <thead> <tr> <th>BRTI Voltage (VBI)</th> <th>Luminance ratio</th> </tr> </thead> <tbody> <tr> <td>0.25V Note4</td> <td>20% (Min. Luminance)</td> </tr> <tr> <td>1.0V</td> <td>100% (Max. Luminance)</td> </tr> </tbody> </table>	BRTI Voltage (VBI)	Luminance ratio	0.25V Note4	20% (Min. Luminance)	1.0V	100% (Max. Luminance)		
BRTI Voltage (VBI)	Luminance ratio								
0.25V Note4	20% (Min. Luminance)								
1.0V	100% (Max. Luminance)								
Pulse width modulation Note1 Note2 Note5	<ul style="list-style-type: none"> • Adjustment <p>Pulse width modulation (PWM) method works, when PWSEL terminal is Low and PWM signal (BRTP signal) is input into BRTP terminal. The luminance is controlled by duty ratio of BRTP signal.</p> <ul style="list-style-type: none"> • Luminance ratio Note3 <table border="1" style="margin-left: auto; margin-right: auto;"> <thead> <tr> <th>Duty ratio</th> <th>Luminance ratio</th> </tr> </thead> <tbody> <tr> <td>0.2 Note4</td> <td>20% (Min. Luminance)</td> </tr> <tr> <td>1.0</td> <td>100% (Max. Luminance)</td> </tr> </tbody> </table>	Duty ratio	Luminance ratio	0.2 Note4	20% (Min. Luminance)	1.0	100% (Max. Luminance)	Low	BRTP signal
Duty ratio	Luminance ratio								
0.2 Note4	20% (Min. Luminance)								
1.0	100% (Max. Luminance)								

Note1: In case of the variable resistor control method and the voltage control method, noises may appear on the display image depending on the input signals timing for LCD panel signal processing board.

Use PWM method, if interference noises appear on the display image!

Note2: The inverter will stop working, if the Low period of BRTP signal is more than 50ms while BRTC signal is High or Open. Then the backlight will not turn on anymore, even if BRTP signal is input again. This is not out of order. The inverter will start to work when power is supplied again.

Note3: These data are the target values.

Note4: Do not set the variable resistor, BRTI voltage and Duty ratio in less than 1.5kΩ or less than 0.25V or less than 20%. Otherwise flicker or display mura may cause, or the lamp may not be turned on.

Note5: See "**4.6.2 Detail of BRTP timing**".

4.6.2 Detail of BRTP timing

(1) Timing diagrams

• Outline chart

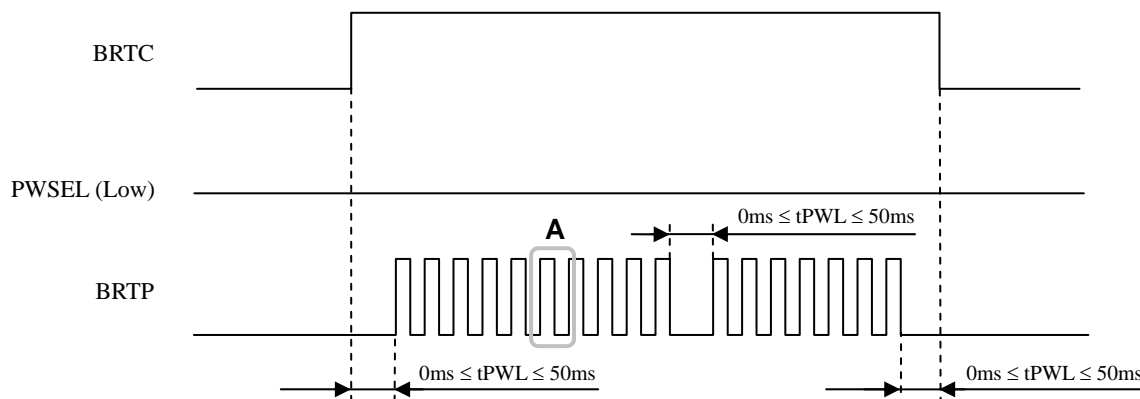

• Detail of **A** part

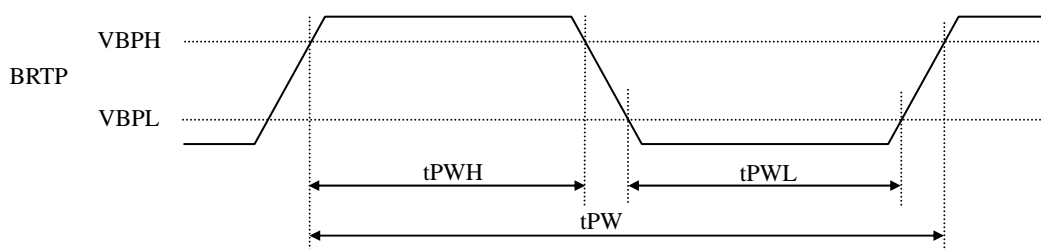

(2) Each parameter

Parameter	Symbol	min.	typ.	max.	Unit	Remarks
Luminance control frequency	FL	185	-	325	Hz	Note1, Note2
Duty ratio	DL	0.2	-	1.0	-	Note1, Note3
Low period	tPWL	0	-	50	ms	Note4

Note1: Definition of parameters is as follows.

$$FL = \frac{1}{tPW} \quad DL = \frac{tPWH}{tPW}$$

Note2: See the following formula for luminance control frequency.

$$\text{Luminance control frequency} = 1/tv \times (n+0.25) \text{ [or } (n + 0.75)]$$

$$n = 1, 2, 3 \dots \dots$$

tv: Vertical cycle (See "4.9.1 Timing characteristics".)

The interference noise of luminance control frequency and input signal frequency for LCD panel signal processing board may appear on a display. Set up luminance control frequency so that the interference noise does not appear!

Note3: See "4.6.1 Luminance control methods".

Note4: If tPWL is more than 50ms, the backlight will be turned off by a protection circuit for inverter. The inverter will start to work when power is supplied again.

PRELIMINARY

4.7 LVDS DATA INPUT MAP

4.7.1 Mode A

Input data		Transmitter				CN1		
		Pin	THC63LVDF83A	Pin	THC63LVD823			
Odd pixel data and control signal	Note1	RA2 →	51 TA0	53 R12		Note2	Pin	Symbol
		RA3 →	52 TA1	54 R13		TA1- →	1	DA0-
		RA4 →	54 TA2	57 R14		TA1+ →	2	DA0+
		RA5 →	55 TA3	58 R15				
		RA6 →	56 TA4	59 R16		TB1- →	3	DA1-
		RA7 →	3 TA5	60 R17		TB1+ →	4	DA1+
		GA2 →	4 TA6	63 G12				
		GA3 →	6 TB0	64 G13		TC1- →	5	DA2-
		GA4 →	7 TB1	65 G14		TC1+ →	6	DA2+
		GA5 →	11 TB2	66 G15			7	GND
		GA6 →	12 TB3	67 G16		TCLK1- →	8	CKA-
		GA7 →	14 TB4	68 G17		TCLK1+ →	9	CKA+
		BA2 →	15 TB5	73 B12				
		BA3 →	19 TB6	74 B13		TD1- →	10	DA3-
		BA4 →	20 TC0	75 B14		TD1+ →	11	DA3+
		BA5 →	22 TC1	76 B15				
		BA6 →	23 TC2	77 B16				
		BA7 →	24 TC3	78 B17				
		Note3	RSVD →	27 TC4	7 RSVD			
		Note3	RSVD →	28 TC5	8 RSVD			
			DE →	30 TC6	9 DE			
			RA0 →	50 TD0	51 R10			
			RA1 →	2 TD1	52 R11			
			GA0 →	8 TD2	61 G10			
			GA1 →	10 TD3	62 G11			
			BA0 →	16 TD4	69 B10			
			BA1 →	18 TD5	70 B11			
		Note3	RSVD →	25 TD6	-			
			CLK →	31 CLKIN	10 CLK			
	Even pixel data		RB2 →	51 TA0	81 R22			
			RB3 →	52 TA1	82 R23		TA2- →	12
		RB4 →	54 TA2	83 R24		TA2+ →	13	DB0+
		RB5 →	55 TA3	84 R25			14	GND
		RB6 →	56 TA4	85 R26		TB2- →	15	DB1-
		RB7 →	3 TA5	86 R27		TB2+ →	16	DB1+
		GB2 →	4 TA6	91 G22			17	GND
		GB3 →	6 TB0	92 G23		TC2- →	18	DB2-
		GB4 →	7 TB1	93 G24		TC2+ →	19	DB2+
		GB5 →	11 TB2	94 G25				
		GB6 →	12 TB3	95 G26		TCLK2- →	20	CKB-
		GB7 →	14 TB4	96 G27		TCLK2+ →	21	CKB+
		BB2 →	15 TB5	99 B22				
		BB3 →	19 TB6	100 B23		TD2- →	22	DB3-
		BB4 →	20 TC0	1 B24		TD2+ →	23	DB3+
		BB5 →	22 TC1	2 B25			24	GND
		BB6 →	23 TC2	5 B26			25	TxSEL0
		BB7 →	24 TC3	6 B27			26	TxSEL1
		Note3	RSVD →	27 TC4	-		27	GND
		Note3	RSVD →	28 TC5	-		28	VDD
		Note3	RSVD →	30 TC6	-		29	VDD
			RB0 →	50 TD0	79 R20		30	VDD
			RB1 →	2 TD1	80 R21			
			GB0 →	8 TD2	89 G20			
			GB1 →	10 TD3	90 G21			
			BB0 →	16 TD4	97 B20			
			BB1 →	18 TD5	98 B21			
		Note3	RSVD →	25 TD6	-			
			CLK →	31 CLKIN	-			

PRELIMINARY

4.7.2 Mode B

Input data		Note1	Transmitter				CN1		
			Pin	DS90CF383, C385			Pin	Symbol	
Odd pixel data and control signal	RA7	→	51	TXIN0					
	RA6	→	52	TXIN1		TA1-	1	DA0-	
	RA5	→	54	TXIN2		TA1+	2	DA0+	
	RA4	→	55	TXIN3					
	RA3	→	56	TXIN4		TB1-	3	DA1-	
	RA2	→	3	TXIN6		TB1+	4	DA1+	
	GA7	→	4	TXIN7					
	GA6	→	6	TXIN8		TC1-	5	DA2-	
	GA5	→	7	TXIN9		TC1+	6	DA2+	
	GA4	→	11	TXIN12			7	GND	
	GA3	→	12	TXIN13		TCLK1-	8	CKA-	
	GA2	→	14	TXIN14		TCLK1+	9	CKA+	
	BA7	→	15	TXIN15					
	BA6	→	19	TXIN18		TD1-	10	DA3-	
	BA5	→	20	TXIN19	1st	TD1+	11	DA3+	
	BA4	→	22	TXIN20					
	BA3	→	23	TXIN21					
	BA2	→	24	TXIN22					
	Note3	RSVD	→	27	TXIN24				
	Note3	RSVD	→	28	TXIN25				
		DE	→	30	TXIN26				
		RA1	→	50	TXIN27				
		RA0	→	2	TXIN5				
		GA1	→	8	TXIN10				
		GA0	→	10	TXIN11				
		BA1	→	16	TXIN16				
		BA0	→	18	TXIN17				
	Note3	RSVD	→	25	TXIN23				
		CLK	→	31	CLKIN				
	Even pixel data	RB7	→	51	TXIN0				
		RB6	→	52	TXIN1		TA2-	12	DB0-
RB5		→	54	TXIN2		TA2+	13	DB0+	
RB4		→	55	TXIN3			14	GND	
RB3		→	56	TXIN4		TB2-	15	DB1-	
RB2		→	3	TXIN6		TB2+	16	DB1+	
GB7		→	4	TXIN7			17	GND	
GB6		→	6	TXIN8		TC2-	18	DB2-	
GB5		→	7	TXIN9		TC2+	19	DB2+	
GB4		→	11	TXIN12					
GB3		→	12	TXIN13		TCLK2-	20	CKB-	
GB2		→	14	TXIN14		TCLK2+	21	CKB+	
BB7		→	15	TXIN15					
BB6		→	19	TXIN18		TD2-	22	DB3-	
BB5		→	20	TXIN19	2nd	TD2+	23	DB3+	
BB4		→	22	TXIN20			24	GND	
BB3		→	23	TXIN21			25	TxSEL0	
BB2		→	24	TXIN22			26	TxSEL1	
Note3		RSVD	→	27	TXIN24			27	GND
Note3		RSVD	→	28	TXIN25			28	VDD
Note3		RSVD	→	30	TXIN26			29	VDD
		RB1	→	50	TXIN27			30	VDD
		RB0	→	2	TXIN5				
		GB1	→	8	TXIN10				
		GB0	→	10	TXIN11				
		BB1	→	16	TXIN16				
		BB0	→	18	TXIN17				
Note3		RSVD	→	25	TXIN23				
		CLK	→	31	CLKIN				

PRELIMINARY

4.7.3 Mode C

Input data		Note1	Transmitter				CN1		
			Pin	DS90CF383, C385			Pin	Symbol	
Odd pixel data and control signal	RA0	→	51	TXIN0			1	DA0-	
	RA1	→	52	TXIN1		TA1-	2	DA0+	
	RA2	→	54	TXIN2		TA1+			
	RA3	→	55	TXIN3					
	RA4	→	56	TXIN4		TB1-	3	DA1-	
	RA5	→	3	TXIN6		TB1+	4	DA1+	
	GA0	→	4	TXIN7					
	GA1	→	6	TXIN8		TC1-	5	DA2-	
	GA2	→	7	TXIN9		TC1+	6	DA2+	
	GA3	→	11	TXIN12			7	GND	
	GA4	→	12	TXIN13		TCLK1-	8	CKA-	
	GA5	→	14	TXIN14		TCLK1+	9	CKA+	
	BA0	→	15	TXIN15					
	BA1	→	19	TXIN18		TD1-	10	DA3-	
	BA2	→	20	TXIN19	1st	TD1+	11	DA3+	
	BA3	→	22	TXIN20					
	BA4	→	23	TXIN21					
	BA5	→	24	TXIN22					
	Note3	RSVD	→	27	TXIN24				
	Note3	RSVD	→	28	TXIN25				
		DE	→	30	TXIN26				
		RA6	→	50	TXIN27				
		RA7	→	2	TXIN5				
		GA6	→	8	TXIN10				
		GA7	→	10	TXIN11				
		BA6	→	16	TXIN16				
		BA7	→	18	TXIN17				
	Note3	RSVD	→	25	TXIN23				
		CLK	→	31	CLKIN				
	Even pixel data	RB0	→	51	TXIN0			12	DB0-
		RB1	→	52	TXIN1		TA2-	13	DB0+
RB2		→	54	TXIN2		TA2+	14	GND	
RB3		→	55	TXIN3					
RB4		→	56	TXIN4		TB2-	15	DB1-	
RB5		→	3	TXIN6		TB2+	16	DB1+	
GB0		→	4	TXIN7			17	GND	
GB1		→	6	TXIN8		TC2-	18	DB2-	
GB2		→	7	TXIN9		TC2+	19	DB2+	
GB3		→	11	TXIN12					
GB4		→	12	TXIN13		TCLK2-	20	CKB-	
GB5		→	14	TXIN14		TCLK2+	21	CKB+	
BB0		→	15	TXIN15					
BB1		→	19	TXIN18		TD2-	22	DB3-	
BB2		→	20	TXIN19	2nd	TD2+	23	DB3+	
BB3		→	22	TXIN20			24	GND	
BB4		→	23	TXIN21			25	TxSEL0	
BB5		→	24	TXIN22			26	TxSEL1	
Note3		RSVD	→	27	TXIN24			27	GND
Note3		RSVD	→	28	TXIN25			28	VDD
Note3		RSVD	→	30	TXIN26			29	VDD
		RB6	→	50	TXIN27			30	VDD
		RB7	→	2	TXIN5				
		GB6	→	8	TXIN10				
		GB7	→	10	TXIN11				
		BB6	→	16	TXIN16				
		BB7	→	18	TXIN17				
Note3		RSVD	→	25	TXIN23				
		CLK	→	31	CLKIN				

PRELIMINARY

Note1: LSB (Least Significant Bit) – RA0, GA0, BA0, RB0, GB0, BB0
 MSB (Most Significant Bit) – RA7, GA7, BA7, RB7, GB7, BB7

Note2: Twist pair wires with 100Ω (Characteristic impedance) should be used between LCD panel signal processing board and LVDS transmitter.

Note3: Input signal RSVD is not used inside the product, but do not keep pin open to avoid noise problem.

4.8 DISPLAY COLORS AND INPUT DATA SIGNALS

This product can display in equivalent to 16,777216 colors in 256 gray scales. Also the relation between display colors and input data signals is as the following table.

Display colors		Data signal (0: Low level, 1: High level)																							
		RA7 RA6 RA5 RA4 RA3 RA2 RA1 RA0								GA7 GA6 GA5 GA4 GA3 GA2 GA1 GA0								BA7 BA6 BA5 BA4 BA3 BA2 BA1 BA0							
		RB7	RB6	RB5	RB4	RB3	RB2	RB1	RB0	GB7	GB6	GB5	GB4	GB3	GB2	GB1	GB0	BB7	BB6	BB5	BB4	BB3	BB2	BB1	BB0
Basic Colors	Black	0	0	0	0	0	0	0	0	0	0	0	0	0	0	0	0	0	0	0	0	0	0	0	0
	Blue	0	0	0	0	0	0	0	0	0	0	0	0	0	0	0	0	1	1	1	1	1	1	1	1
	Red	1	1	1	1	1	1	1	1	0	0	0	0	0	0	0	0	0	0	0	0	0	0	0	0
	Magenta	1	1	1	1	1	1	1	1	0	0	0	0	0	0	0	0	1	1	1	1	1	1	1	1
	Green	0	0	0	0	0	0	0	0	1	1	1	1	1	1	1	1	0	0	0	0	0	0	0	0
	Cyan	0	0	0	0	0	0	0	0	1	1	1	1	1	1	1	1	1	1	1	1	1	1	1	1
	Yellow	1	1	1	1	1	1	1	1	1	1	1	1	1	1	1	1	0	0	0	0	0	0	0	0
	White	1	1	1	1	1	1	1	1	1	1	1	1	1	1	1	1	1	1	1	1	1	1	1	1
Red gray scale	Black	0	0	0	0	0	0	0	0	0	0	0	0	0	0	0	0	0	0	0	0	0	0	0	0
		0	0	0	0	0	0	0	1	0	0	0	0	0	0	0	0	0	0	0	0	0	0	0	0
	dark	0	0	0	0	0	0	1	0	0	0	0	0	0	0	0	0	0	0	0	0	0	0	0	0
	↑					:							:								:				
	↓					:							:								:				
	bright	1	1	1	1	1	1	0	1	0	0	0	0	0	0	0	0	0	0	0	0	0	0	0	0
Red	1	1	1	1	1	1	1	0	0	0	0	0	0	0	0	0	0	0	0	0	0	0	0	0	
Red	1	1	1	1	1	1	1	1	0	0	0	0	0	0	0	0	0	0	0	0	0	0	0	0	
Green gray scale	Black	0	0	0	0	0	0	0	0	0	0	0	0	0	0	0	0	0	0	0	0	0	0	0	0
		0	0	0	0	0	0	0	0	0	0	0	0	0	0	0	1	0	0	0	0	0	0	0	0
	dark	0	0	0	0	0	0	0	0	0	0	0	0	0	0	1	0	0	0	0	0	0	0	0	0
	↑					:							:								:				
	↓					:							:								:				
	bright	0	0	0	0	0	0	0	0	1	1	1	1	1	1	0	1	0	0	0	0	0	0	0	0
Green	0	0	0	0	0	0	0	0	1	1	1	1	1	1	1	0	0	0	0	0	0	0	0	0	
Green	0	0	0	0	0	0	0	0	1	1	1	1	1	1	1	1	0	0	0	0	0	0	0	0	
Blue gray scale	Black	0	0	0	0	0	0	0	0	0	0	0	0	0	0	0	0	0	0	0	0	0	0	0	0
		0	0	0	0	0	0	0	0	0	0	0	0	0	0	0	0	0	0	0	0	0	0	0	1
	dark	0	0	0	0	0	0	0	0	0	0	0	0	0	0	0	0	0	0	0	0	0	0	1	0
	↑					:							:								:				
	↓					:							:								:				
	bright	0	0	0	0	0	0	0	0	0	0	0	0	0	0	0	0	1	1	1	1	1	1	0	1
Blue	0	0	0	0	0	0	0	0	0	0	0	0	0	0	0	0	1	1	1	1	1	1	1	0	
Blue	0	0	0	0	0	0	0	0	0	0	0	0	0	0	0	0	1	1	1	1	1	1	1	1	

4.9 INPUT SIGNAL TIMINGS

4.9.1 Timing characteristics

Parameter	Symbol	min.	typ.	max.	Unit	Remarks	
CLK	Frequency	1/ tc	60.0	64.5	65.0	MHz	LVDS transmitter input
	Pulse width	tc	15.38	15.5	-	ns	
	Duty	-	See the data sheet of LVDS transmitter.			-	
	Rise, fall	-				ns	
Horizontal	Cycle	th	13.1	13.3	19.2	μ s	-
			848	860	1,156	CLK	
	Display period	thd	800			CLK	-
Vertical	Cycle	1/tv	59	60	61	Hz	-
		tv	1,206	1,250	-	H	
	Display period	tvd	1,200			H	-
DE, DATA	Setup time	-	See the data sheet of LVDS transmitter.			ns	-
	Hold time	-				ns	
	Rise, fall	-				ns	

4.9.2 Input signal timing chart

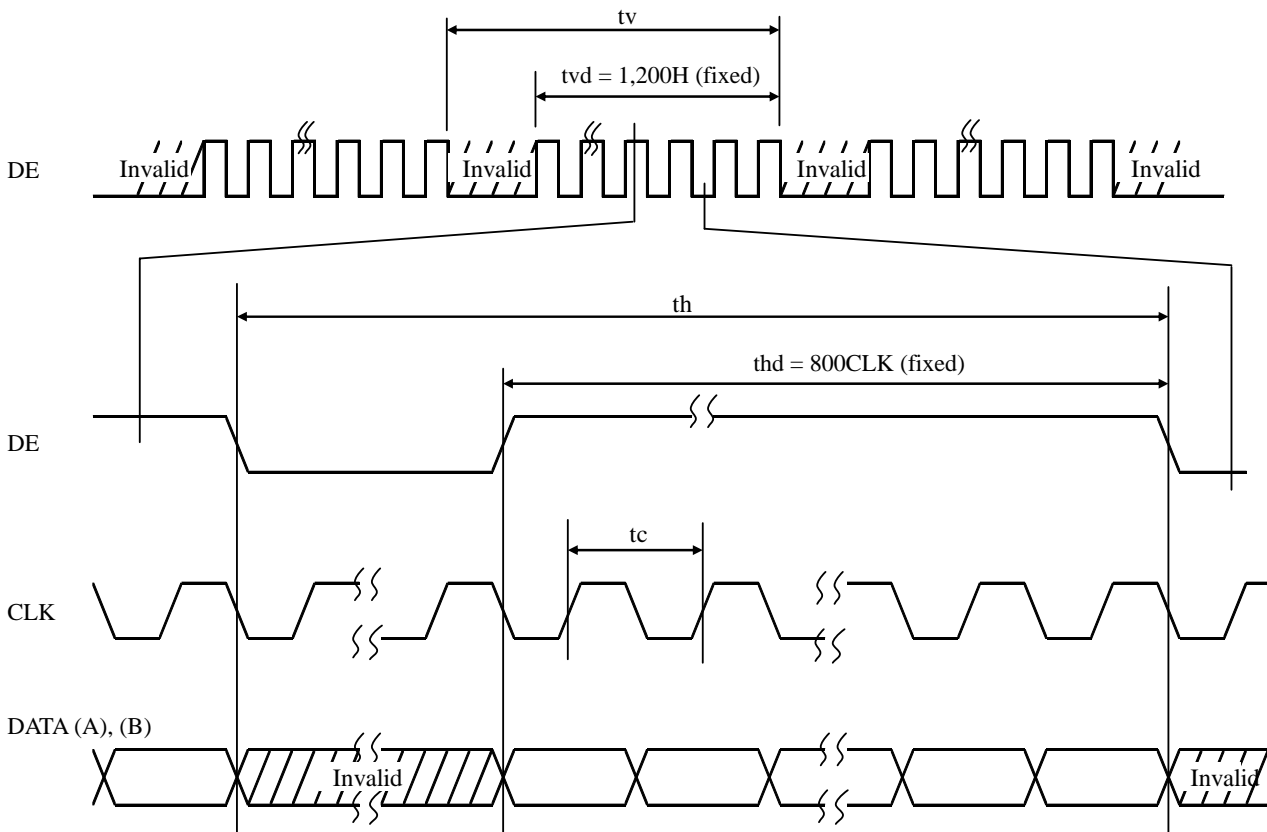

PRELIMINARY

4.10 DISPLAY POSITIONS

Even pixel: RA= Red data
GA= Green data
BA= Blue data

Odd pixel: RB= Red data
GB= Green data
BB= Blue data

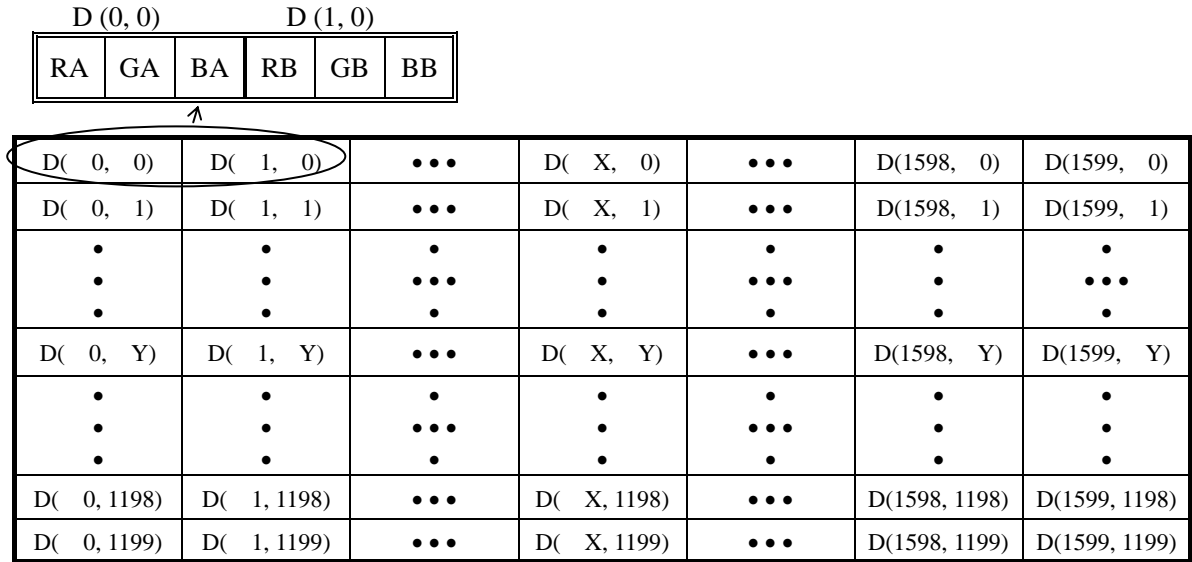

4.11 TEN-bit LOOK UP TABLE FOR GAMMA ADJUSTMENT

Adjustment of gamma characteristics for each 8-bit RGB data is possible by using built-in 10-bit LUT (look up table) for Gamma characteristics.

The LUT is set with the serial data. The combination of the control command determines the R/W actions.: READ, Random/Sequential Address WRITE and Individual/Simultaneous RGB setting.

The serial data is composed as Table1.

Table1: Serial data Composition

DATA	DATA name	Function	Remarks
D31	CMD5	Control Command	See Table2 and 3.
D30	CMD4	Control Command	
D29	CMD3	Control Command	
D28	CMD2	Control Command	
D27	CMD1	Control Command	
D26	CMD0	Control Command	
D25	ADD9	LUT Address (MSB)	See Table4.
D24	ADD8	LUT Address	
D23	ADD7	LUT Address	
D22	ADD6	LUT Address	
D21	ADD5	LUT Address	
D20	ADD4	LUT Address	
D19	ADD3	LUT Address	
D18	ADD2	LUT Address	
D17	ADD1	LUT Address	
D16	ADD0	LUT Address (LSB)	
D15	Dummy	Dummy Data "0"	See Table5.
D14	Dummy	Dummy Data "0"	
D13	Dummy	Dummy Data "0"	
D12	Dummy	Dummy Data "0"	
D11	Dummy	Dummy Data "0"	
D10	Dummy	Dummy Data "0"	
D9	DATA9	LUT Data (MSB)	
D8	DATA8	LUT Data	
D7	DATA7	LUT Data	
D6	DATA6	LUT Data	
D5	DATA5	LUT Data	
D4	DATA4	LUT Data	
D3	DATA3	LUT Data	
D2	DATA2	LUT Data	
D1	DATA1	LUT Data	
D0	DATA0	LUT Data (LSB)	

PRELIMINARY

Table2: Command table (CMD5 to CMD0: 6-bit)

DATA name	Parameter	Remarks
CMD5	Selection of WRITE/READ mode "1": WRITE mode "0": READ mode	In case of "0", must be set as follows. CMD4: "1", CMD3: "0", CMD2: "1" CMD1: "0", CMD0: "0"
CMD4	Must be set to "1".	-
CMD3	Selection of Random/Sequential Address WRITE "1": Random Address WRITE "0": Sequential Address WRITE	-
CMD2	Must be set to "1".	-
CMD1	Selection of Individual/Simultaneous RGB setting "1": Individual RGB setting "0": Simultaneous RGB setting	"1": Select the color by using ADD9 and ADD8. (See Table4.) "0": ADD9 and ADD8 are invalid.
CMD0	Must be set to "0".	-

Table3: Command Combination table (CMD5 to CMD0: 6-bit)

CMD5	CMD4	CMD3	CMD2	CMD1	CMD0	Mode
1	1	1	1	1	0	Random Address WRITE, Individual RGB setting
1	1	1	1	0	0	Random Address WRITE, Simultaneous RGB setting
1	1	0	1	1	0	Sequential Address WRITE, Individual RGB setting
1	1	0	1	0	0	Sequential Address WRITE, Simultaneous RGB setting
0	1	0	1	0	0	READ mode

*Other combinations are prohibited, and may cause function error.

Table4: Address table (ADD9 to ADD0: 10-bit)

DATA name	Parameter	Remarks
ADD9	Sub-pixel selection ADD[9:8]= 0:0 Red 0:1 Green 1:0 Blue 1:1 ON/OFF selection of Gamma Correction	When "ADD[9:8]=1:1", ON/OFF of Gamma correction can select according to the GMA[2:0]. (See Table6 and Table7.)
ADD8		
ADD7		
ADD6		
ADD5	LUT Address 256 address = 00h - FFh	When ADD[9:8] = 1:1, ADD[7:0] must be set to 00h.
ADD4		
ADD3		
ADD2		
ADD1		
ADD0		

PRELIMINARY

Table5: Data table (DATA15 to DATA0: 16-bit)

DATA	DATA name	Parameter	Remarks
DATA15	Dummy	Dummy Data Must be set to "0".	-
DATA14	Dummy		
DATA13	Dummy		
DATA12	Dummy		
DATA11	Dummy		
DATA10	Dummy		
DATA9	DATA9	[MSB]	-
DATA8	DATA8	10-bit LUT Data 000h - 3FFh	
DATA7	DATA7		
DATA6	DATA6		
DATA5	DATA5		
DATA4	DATA4		
DATA3	DATA3		
DATA2	DATA2		
DATA1	DATA1		
DATA0	DATA0	[LSB]	

Table6: Gamma correction table (DATA15 to DATA0: 16bit)

DATA	DATA name	Parameter	Remarks
DATA15	Dummy	Dummy Data Must be set to "0".	-
DATA14	Dummy		
DATA13	Dummy		
DATA12	Dummy		
DATA11	Dummy		
DATA10	Dummy		
DATA9	Dummy		
DATA8	Dummy		
DATA7	Dummy		
DATA6	Dummy		
DATA5	Dummy		
DATA4	Dummy		
DATA3	Dummy	[MSB] GMA Data [LSB]	See Table7.
DATA2	GMA2		
DATA1	GMA1		
DATA0	GMA0		

Table7: Control code GMA[2:0]

GMA2	GMA1	GMA0	Function
0	0	0	No correction (Initial setting)
0	0	1	Correction according to the LUT Data. Note1

*Other combinations are prohibited, and may cause function error.

Note1: Initial setting of the LUT is undefined data. The LUT should be enabled by setting of the GMA after writing the LUT data in all the 256 addresses, in order to avoid undefined data display.

Note2: Transfer the data every power-on, because the LUT data isn't stored in the LCD module.

Note3: As writing and reading the LUT data, a noise may appear on the display image. In order to prevent the noise appearing on the display, following measures should be performed.

(1)The LUT data should be rewritten during invalid period of pixel data (See "**4.9 INPUT SIGNAL TIMINGS**").

(2) The LUT data should be rewritten when the Gamma Correction is OFF (GMA[2:0] = 000).

4.12 LUT SERIAL COMMUNICATION TIMINGS

4.12.1 Timing Chart

(1) READ Timing Chart

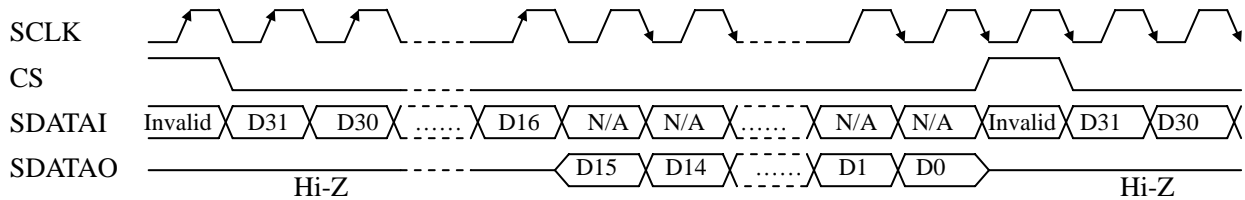

(2) Random Address WRITE Timing Chart

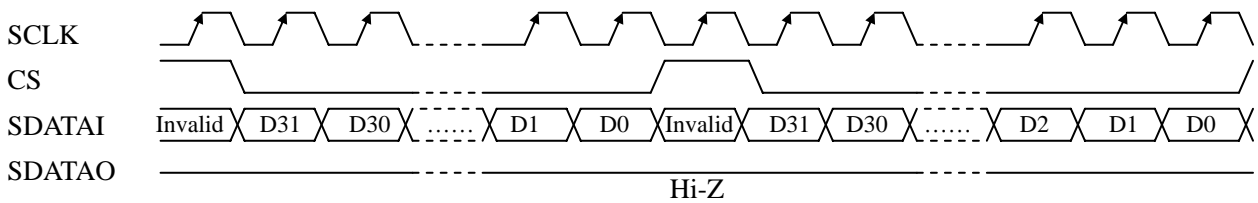

(3) Sequential Address WRITE Timing Chart

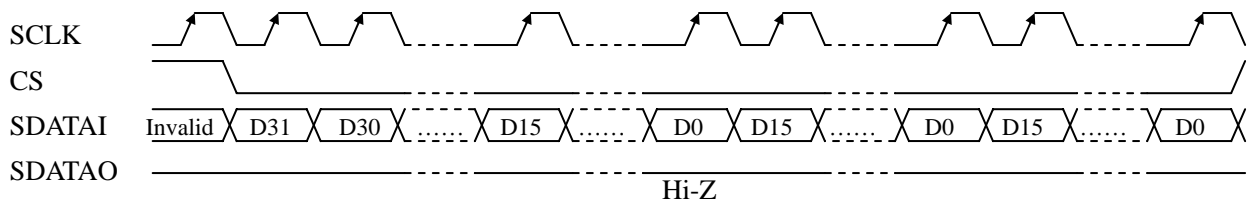

4.12.2 Timing specifications

Parameter	Symbol	min.	typ.	max.	Unit	Remarks
SCLK Frequency	1/Tsck	-	-	5	MHz	-
SCLK Pulse Width (WRITE)	Twsck	50	-	-	ns	-
SCLK Pulse Width (READ)	Twsck	5	-	-	tc	Note1
SDATI-SCLK Setup Time	Tds	50	-	-	ns	-
SDATI-SCLK Hold Time	Tdh	50	-	-	ns	-
CS-SCLK Setup Time	Tcs	50	-	-	ns	-
CS-SCLK Hold Time	Tch	50	-	-	ns	-

Note1: At the READ of the serial communication mode, the SCLK Pulse Width (Twsck) must be greater than 5CLK (5 tc's). (See "4.9.1 Timing characteristics".)

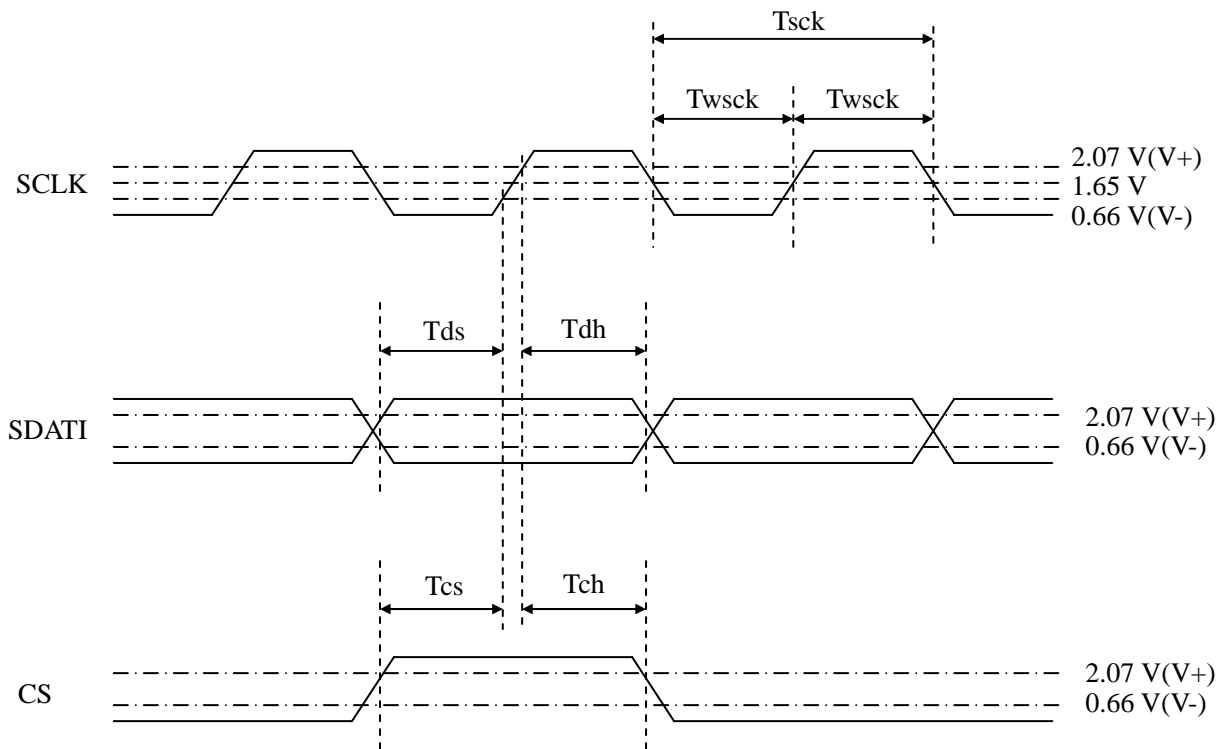

Note2: During the serial communication mode, the display noise may appear because of rewriting the data. To avoid this, rewrite the LUT data when the pixel data is invalid or the Gamma Correction is OFF (GMA[2:0] = 000). The external noise may cause the data change, refresh the data regularly according to need.

4.13 OPTICS

4.13.1 Optical characteristics

(Note1, Note2)

Parameter	Condition	Symbol	min.	typ.	max.	Unit	Measuring instrument	Remarks	
Luminance	White at center $\theta R = 0^\circ, \theta L = 0^\circ, \theta U = 0^\circ, \theta D = 0^\circ$	L	TBD	950	-	cd/m ²	BM-5A or SR-3	-	
Contrast ratio	White/Black at center $\theta R = 0^\circ, \theta L = 0^\circ, \theta U = 0^\circ, \theta D = 0^\circ$	CR	TBD	800	-	-	BM-5A or SR-3	Note3	
Luminance uniformity	White $\theta R = 0^\circ, \theta L = 0^\circ, \theta U = 0^\circ, \theta D = 0^\circ$	LU	-	1.15	1.25	-	BM-5A	Note4	
Chromaticity	White	x coordinate	Wx	0.293	0.313	0.333	-	SR-3	Note5
		y coordinate	Wy	0.309	0.329	0.349	-		
	Red	x coordinate	Rx	-	TBD	-	-		
		y coordinate	Ry	-	TBD	-	-		
	Green	x coordinate	Gx	-	TBD	-	-		
		y coordinate	Gy	-	TBD	-	-		
Blue	x coordinate	Bx	-	TBD	-	-			
	y coordinate	By	-	TBD	-	-			
Response time	Black to White	Ton	-	14	TBD	ms	BM-5A	Note6 Note7	
	White to Black	Toff	-	11	TBD	ms			
Viewing angle	Right	$\theta U = 0^\circ, \theta D = 0^\circ, CR \geq 10$	θR	70	85	-	EZ Contrast	Note8	
	Left	$\theta U = 0^\circ, \theta D = 0^\circ, CR \geq 10$	θL	70	85	-			
	Up	$\theta R = 0^\circ, \theta L = 0^\circ, CR \geq 10$	θU	70	85	-			
	Down	$\theta R = 0^\circ, \theta L = 0^\circ, CR \geq 10$	θD	70	85	-			

Note1: These are initial characteristics.

Note2: Measurement conditions are as follows.

Ta = 25°C, VDD = 12.0V, VDDB = 24.0V, Luminance control = maximum,

Display mode: UXGA, Horizontal cycle = 1/75.19 kHz, Vertical cycle = 1/60.0Hz

Optical characteristics are measured after 20 minutes from working the product, in the dark room. Also measurement methods are as follows.

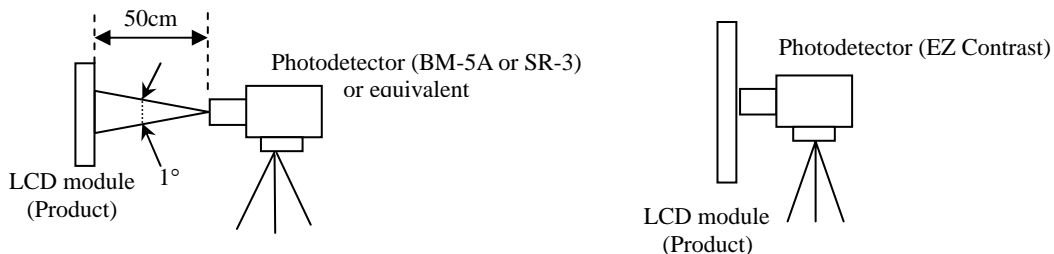

Note3: See "4.13.2 Definition of contrast ratio".

Note4: See "4.13.3 Definition of luminance uniformity".

Note5: These coordinates are found on CIE 1931 chromaticity diagram.

Note6: Product surface temperature: TopF = 35°C

Note7: See "4.13.4 Definition of response times".

Note8: See "4.13.5 Definition of viewing angles".

4.13.2 Definition of contrast ratio

The contrast ratio is calculated by using the following formula.

$$\text{Contrast ratio (CR)} = \frac{\text{Luminance of white screen}}{\text{Luminance of black screen}}$$

4.13.3 Definition of luminance uniformity

The luminance uniformity is calculated by using following formula.

$$\text{Luminance uniformity (LU)} = \frac{\text{Maximum luminance from ① to ⑤}}{\text{Minimum luminance from ① to ⑤}}$$

The luminance is measured at near the 5 points shown below.

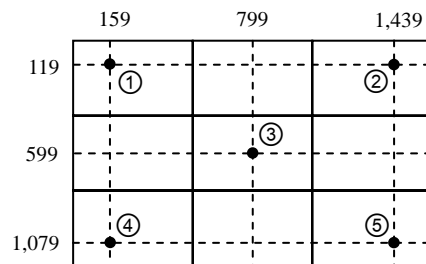

4.13.4 Definition of response times

Response time is measured, the luminance changes from "black" to "white", or "white" to "black" on the same screen point, by photo-detector. Ton is the time it takes the luminance change from 10% up to 90%. Also Toff is the time it takes the luminance change from 90% down to 10% (See the following diagram.).

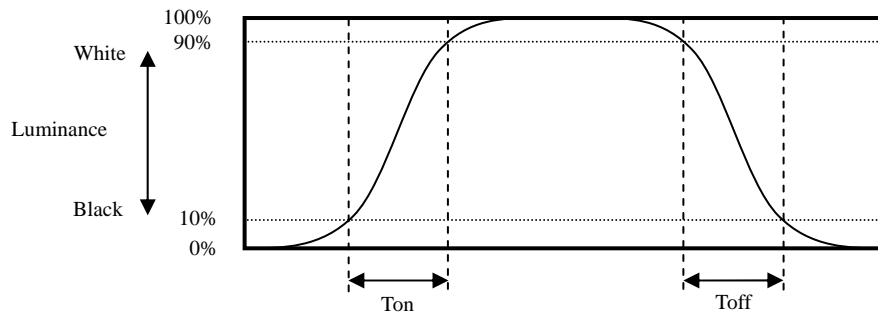

4.13.5 Definition of viewing angles

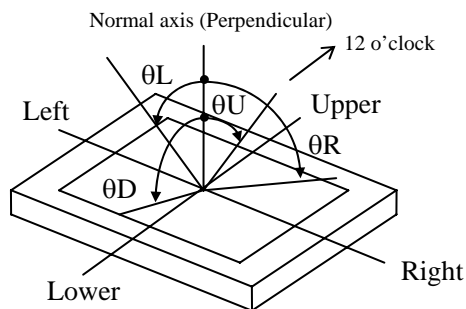

PRELIMINARY

5. RELIABILITY TESTS

Test item	Condition	Judgment Note1
High temperature and humidity (Operation)	① $60 \pm 2^{\circ}\text{C}$, RH = 60%, 240hours ② Display data is white.	No display malfunctions
Heat cycle (Operation)	① $0 \pm 3^{\circ}\text{C}$...1hour $55 \pm 3^{\circ}\text{C}$...1hour ② 50cycles, 4hours/cycle ③ Display data is white.	
Thermal shock (Non operation)	① $-20 \pm 3^{\circ}\text{C}$...30minutes $60 \pm 3^{\circ}\text{C}$...30minutes ② 100cycles, 1hour/cycle ③ Temperature transition time is within 5 minutes.	
Vibration (Non operation)	① 5 to 100Hz, 11.76m/s^2 ② 1 minute/cycle ③ X, Y, Z direction ④ 10 times each directions	No display malfunctions No physical damages
Mechanical shock (Non operation)	① 294m/s^2 , 11ms ② X, Y, Z direction ③ 3 times each directions	
ESD (Operation)	① 150pF, 150Ω, $\pm 10\text{kV}$ ② 9 places on a panel surface Note2 ③ 10 times each places at 1 sec interval	No display malfunctions
Dust (Operation)	① Sample dust: No.15 (by JIS-Z8901) ② 15 seconds stir ③ 8 times repeat at 1 hour interval	
Low pressure	Non-operation	No display malfunctions
	Operation	
	① 15 kPa (Equivalent to altitude 13,600m) ② $-20^{\circ}\text{C} \pm 3^{\circ}\text{C}$...24 hours ③ $+60^{\circ}\text{C} \pm 3^{\circ}\text{C}$...24 hours	
	① 53.3 kPa (Equivalent to altitude 4,850m) ② $0^{\circ}\text{C} \pm 3^{\circ}\text{C}$...24 hours ③ $+55^{\circ}\text{C} \pm 3^{\circ}\text{C}$...24 hours	

Note1: Display and appearance are checked under environmental conditions equivalent to the inspection conditions of defect criteria.

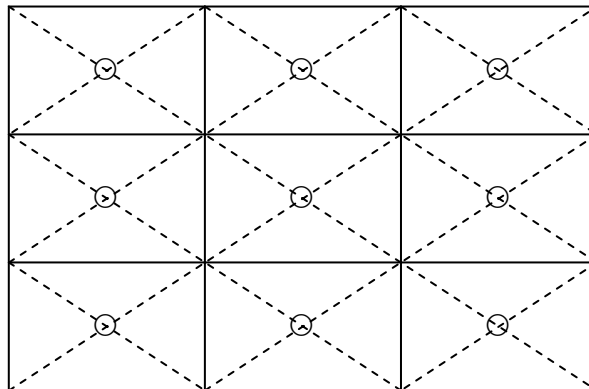

Note2: See the following figure for discharge points



6. PRECAUTIONS

6.1 MEANING OF CAUTION SIGNS

The following caution signs have very important meaning. **Be sure to read "6.2 CAUTIONS" and "6.3 ATTENTIONS", after understanding these contents!**

	This sign has the meaning that customer will be injured by himself or the product will sustain a damage, if customer has wrong operations.
	This sign has the meaning that customer will get an electrical shock, if customer has wrong operations.
	This sign has the meaning that customer will be injured by himself, if customer has wrong operations.

6.2 CAUTIONS



*** Do not touch the working backlight and inverter. There is a danger of an electric shock.**



*** Do not touch the working backlight and inverter. There is a danger of burn injury.**
*** Do not shock and press the LCD panel and the backlight! There is a danger of breaking, because they are made of glass. (Shock: To be not greater 294m/s² and to be not greater 11ms, Pressure: To be not greater 19.6N (φ16mm jig))**

6.3 ATTENTIONS

6.3.1 Handling of the product

- ① Take hold of both ends without touching the circuit board when the product (LCD module) is picked up from inner packing box to avoid broken down or misadjustment, because of stress to mounting parts on the circuit board.
- ② Do not hook nor pull cables such as lamp cable, and so on, in order to avoid any damage.
- ③ When the product is put on the table temporarily, display surface must be placed downward.
- ④ When handling the product, take the measures of electrostatic discharge with such as earth band, ionic shower and so on, because the product may be damaged by electrostatic.
- ⑤ The torque for product mounting screws must never exceed 0.735 N·m. Higher torque might result in distortion of the bezel. And the length of product mounting screws must be ≤ 4.7mm.

- ⑥ The product must be installed using mounting holes without undue stress such as bends or twist (See outline drawings). And do not add undue stress to any portion (such as bezel flat area). Bends or twist described above and undue stress to any portion may cause display mura.
Recommended installing method: Ideal plane "A" is defined by one mounting hole (datum point) and other mounting holes. The ideal plane "A" should be the same plane within ± 0.3 mm.

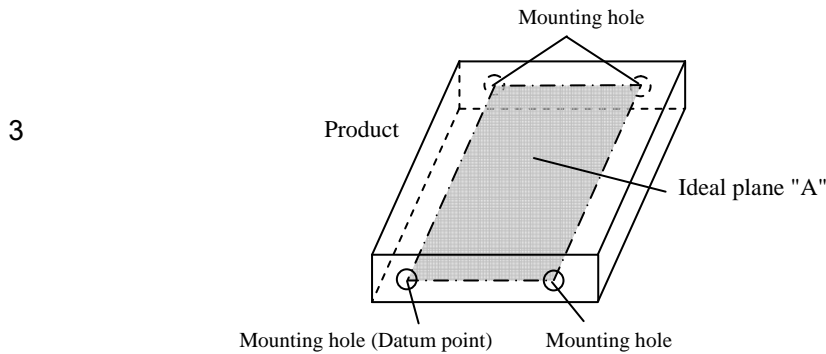

- ⑦ Do not press or rub on the sensitive product surface. When cleaning the product surface, use of the cloth with ethanolic liquid such as screen cleaner for LCD is recommended.
- ⑧ Do not push nor pull the interface connectors while the product is working.
- ⑨ When handling the product, use of an original protection sheet on the product surface (polarizer) is recommended for protection of product surface. Adhesive type protection sheet may change color or characteristics of the polarizer.
- ⑩ Usually liquid crystals don't leak through the breakage of glasses because of the surface tension of thin layer and the construction of LCD panel. But, if you contact with liquid crystal for the worst, please wash it out with soap.

6.3.2 Environment

- ① Do not operate or store in high temperature, high humidity, dewdrop atmosphere or corrosive gases. Keep the product in packing box with antistatic pouch in room temperature to avoid dusts and sunlight, when storing the product.
- ② In order to prevent dew condensation occurring by temperature difference, the product packing box should be opened after enough time being left under the environment of an unpacking room. Evaluate the leaving time sufficiently because a situation of dew condensation occurring is changed by the environmental temperature and humidity. (Recommended leaving time: 6 hours or more with packing state)
- ③ Do not operate in high magnetic field. Circuit boards may be broken down by it.
- ④ This product is not designed as radiation hardened.

6.3.3 Characteristics

The following items are neither defects nor failures.

- ① Response time, luminance and color may be changed by ambient temperature.
- ② Display mura, flicker, vertical seam or small spot may be observed depending on display patterns.
- ③ Optical characteristics (e.g. luminance, display uniformity, etc.) gradually is going to change depending on operating time, and especially low temperature, because the LCD has cold cathode fluorescent lamps.
- ④ Do not display the fixed pattern for a long time because it may cause image sticking. Use a screen saver, if the fixed pattern is displayed on the screen.

- ⑤ The display color may be changed depending on viewing angle because of the use of condenser sheet in the backlight.
- ⑥ Optical characteristics may be changed depending on input signal timings.
- ⑦ The interference noise between input signal frequency for this product's signal processing board and luminance control frequency of the inverter may appear on a display. Set up luminance control frequency of the inverter so that the interference noise does not appear.

6.3.4 Other

- ① All VDD, VDDB, GND and GNDB terminals should be used without any non-connected lines.
- ② Do not disassemble a product or adjust variable resistors.
- ③ See “REPLACEMENT MANUAL FOR INVERTER”, when replacing the inverter.
- ④ Pack the product with original shipping package, in order to avoid any damages during transportation, when returning the product to NEC for repair and so on.
- ⑤ The LCD module by itself or integrated into end product should be packed and transported with display in the vertical position. Otherwise the display characteristics may be degraded.

7. OUTLINE DRAWINGS
7.1 FRONT VIEW

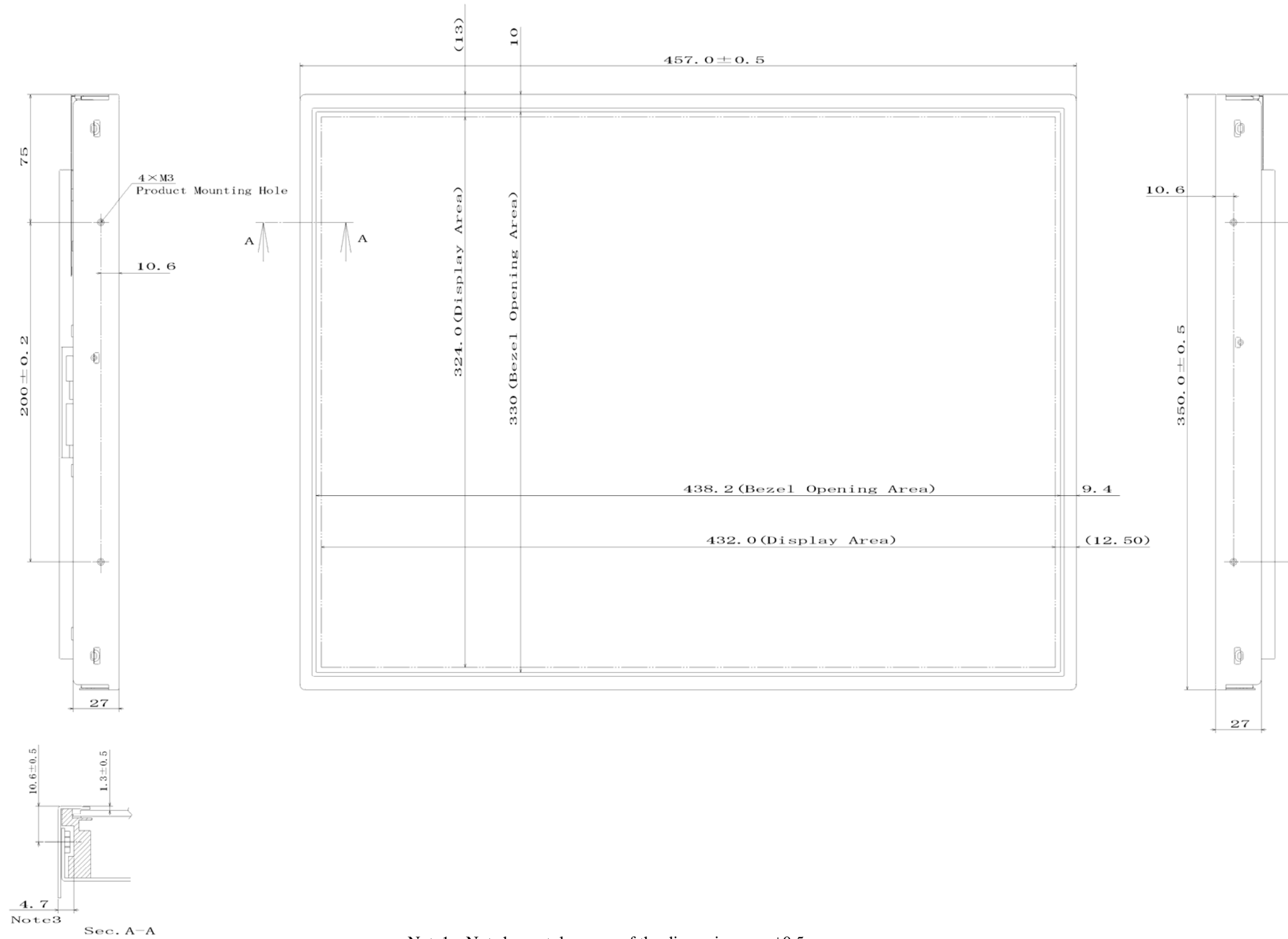





- Note1: Not shown tolerances of the dimensions are ±0.5mm.
- Note2: The torque for product mounting screws must never exceed 0.735N·m.
- Note3: The length of product mounting screws from surface of plate must be ≤ 4.7mm.
- Note4: The values in parentheses are for reference.

Unit: mm

PRELIMINARY

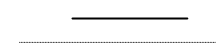
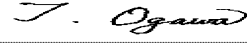
REVISION HISTORY

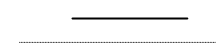
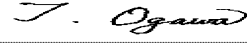
The inside of latest specifications is revised to the clerical error and the major improvement of previous edition. Only a changed part such as functions, characteristic value and so on that may affect a design of customers, are described especially below.

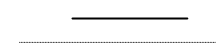
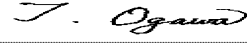
Edition	Document number	Prepared date	Revision contents and signature									
1st edition	DOD-PP-0280	Jun. 29, 2007	<p>Revision contents</p> <p>New issue</p> <p>Signature of writer</p> <table data-bbox="571 712 1433 835"><tr><td data-bbox="571 712 842 741"><i>Approved by</i></td><td data-bbox="842 712 1129 741"><i>Checked by</i></td><td data-bbox="1129 712 1433 741"><i>Prepared by</i></td></tr><tr><td data-bbox="571 741 842 792"></td><td data-bbox="842 741 1129 792"></td><td data-bbox="1129 741 1433 792"></td></tr><tr><td data-bbox="571 792 842 835">T. OGAWA</td><td data-bbox="842 792 1129 835"></td><td data-bbox="1129 792 1433 835">T. OGAWA</td></tr></table>	<i>Approved by</i>	<i>Checked by</i>	<i>Prepared by</i>				T. OGAWA		T. OGAWA
<i>Approved by</i>	<i>Checked by</i>	<i>Prepared by</i>										
												
T. OGAWA		T. OGAWA										